

B **BINA PLASTIC**
INDUSTRIES SDN BHD
(Co.No. 54840-T)

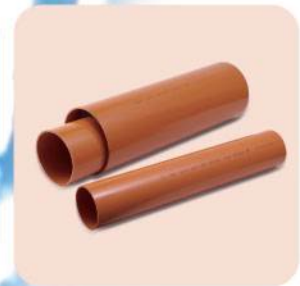

BBB™
UPVC PIPES & FITTINGS

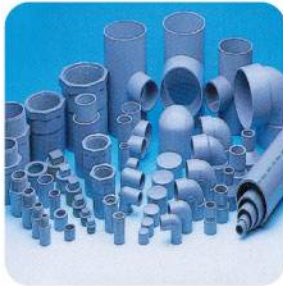

INTRODUCTION



 **BINA PLASTIC**
INDUSTRIES SDN BHD

Bina Plastic Industries Sdn. Bhd. a company established in 1973 by its founder, Mr. Ong Ken Sim, specializes in producing **UPVC**, **HDPE** and **ABS** pipes and fittings. From its modest beginnings in 1973, our company has grown dynamically with four large modern factories, now located in Balakong New Village Industrial Estate, Selangor, Malaysia with total area covering 20 acres and total staff strength of over 400 employees.

With the current monthly production capacity being 3,000 metric ton UPVC products and 800 metric ton for HDPE products and ABS products, we are one of the leading supplier for the complete range of UPVC pipes and fittings and also a main manufacturer of HDPE and ABS pipes in Malaysia.

Pipe and fitting systems that printed with our trademark "**BBB™**" are used in broad cross section of markets including:

- i) Cold water services
- ii) Soil, waste and ventilating
- iii) Underground drainage and sewerage
- iv) Conduits and telecommunication



UPVC PIPES AND FITTINGS

General

Polyvinyl Chloride, commonly abbreviated PVC, is a widely used thermoplastic. Unplasticized PVC (UPVC) is rigid type of PVC means without the use of plasticizing agents. PVC has long been considered to be one of the most durable polymers for both underground and aboveground piping systems and is commonly used for a variety of pressure and gravity applications including potable water distribution, irrigation systems and sewer industries. Its light weight, high strength and low reactivity make it particularly well-suited to these purposes.

UPVC Pipes and Fittings Characteristics

Light Weight

UPVC's lighter weight makes it easier and less costly to handle, transport and install. In fact, most UPVC pipe and fitting sizes can be handled manually, reducing the need for expensive installation equipment.

Higher Flow Rates

UPVC pipes provide smoother wall surfaces that reduce fluid friction and resistance to flow, thus increase flow rates. Superior hydraulics leading to lower pumping costs.

Corrosion Resistance

UPVC pipes and fittings are non-conductors of electricity and immune to electrochemical reactions caused by acids, alkalis and salts that cause corrosion in metals.

Chemical Resistance

UPVC pipes and fittings exhibit resistance to a wide range of chemical reagents and are resistant to chemicals normally found or used in homes.

Flame Resistance

UPVC pipes and fittings are difficult to ignite and will not continue burning in the absence of an external ignition source.

Impact Strength

Under normal conditions, UPVC pipes possess relatively high resistance to impact damage when compared to pipes made from clay, concrete and most other conventional materials.

Favorable Cost

UPVC pipe and fitting are competitive with other materials, particularly when installation and life cycle operating costs are taken into consideration.



UPVC PRESSURE PIPES WITH SOLVENT CEMENT JOINT

This pipe is complied with **MS 628**, **MS 762** and **JIS K 6741** (JIS Standard), which intended to be used for pressure application in cold water services. The pressure rating of the pipes are as following:

- Class O (Non - Pressure)
- Class B (PN 6)
- Class C (PN 9)
- Class D (PN 12)
- Class E (PN 15)
- Class 7



SPECIFICATIONS OF PRESSURE PIPES

Colour	Grey
Length	5.8m
Type of Joint	Solvent Cement Weld Joint

STANDARD				Wall Thickness (mm)											
				MS 762 (BS 3506)				MS 628 (BS 3505)				MS 762 (BS 3506)			
Nominal Size		Outside Diameter (mm)		Class O		Class B (PN 6)		Class C (PN 9)		Class D (PN 12)		Class E (PN 15)		Class 7	
in	mm	Min	Max	Min	Max	Min	Max	Min	Max	Min	Max	Min	Max	Min	Max
½	15	21.2	21.5									1.7	2.1	3.7	4.3
¾	20	26.6	26.9									1.9	2.5	3.9	4.5
1	25	33.4	33.7									2.2	2.7	4.5	5.2
1¼	32	42.1	42.4							2.2	2.7	2.7	3.2	4.8	5.5
1½	40	48.1	48.4	1.8	2.2					2.5	3.0	3.1	3.7	5.1	5.9
2	50	60.2	60.5	1.8	2.2			2.5	3.0	3.1	3.7	3.9	4.5	5.5	6.3
2½	65	75.0	75.3	1.8	2.2			3.0	3.5	3.9	4.5	4.8	5.5		
3	80	88.7	89.1	1.8	2.2	2.9	3.4	3.5	4.1	4.6	5.3	5.7	6.6		
4	100	114.1	114.5	2.3	2.8	3.4	4.0	4.5	5.2	6.0	6.9	7.3	8.4		
5	125	140.0	140.4	2.6	3.1	3.8	4.4	5.5	6.4	7.3	8.4	9.0	10.4		
6	155	168.0	168.5	3.1	3.7	4.5	5.2	6.6	7.6	8.8	10.2	10.8	12.5		
8	200	218.8	219.4	3.1	3.7	5.3	6.1	7.8	9.0	10.3	11.9	12.6	14.5		
10	250	272.6	273.4	3.1	3.7	6.6	7.6	9.7	11.2	12.8	14.8	15.7	18.1		
12	300	323.4	324.3	3.1	3.7	7.8	9.0	11.5	13.3	15.2	17.7	18.7	21.6		

STANDARD		Wall Thickness (mm)					
		JIS K 6741					
Normal Size	Outside Diameter (mm)		Type VU (AE) 6.0 BAR		Type VP (AW) 10.0 BAR		
	mm	Min	Max	Min	Max	Min	Max
200	215.3	216.7	6.5	7.5	10.3	11.7	
250	266.1	267.9	7.8	9.0	12.7	14.5	
300	317.0	319.0	9.2	10.6	15.1	17.3	

UPVC PRESSURE PIPES WITH RUBBER - RING JOINT



Colour : Grey Or Blue
Length : 6m
Type of Joint : Rubber - Ring Joint

STANDARD					Wall Thickness (mm)			
					MS 628 : PART 2 : SECTION 2.1			
Normal Size		Outside Diameter (mm)		Insertion Length (A) (mm)	Class D (PN 12)		Class E (PN 15)	
in.	mm	Min	Max		Min	Max	Min	Max
4	100	114.1	114.5	86.20	6.0	6.9	7.3	8.4
6	155	168.0	168.5	91.90	8.8	10.2	10.8	12.5
8	200	218.8	219.4	115.10	10.3	11.9	12.6	14.5
10	250	272.6	273.4	128.60	12.8	14.8	15.7	18.1
12	300	323.4	324.3	136.00	15.2	17.7	18.7	21.6

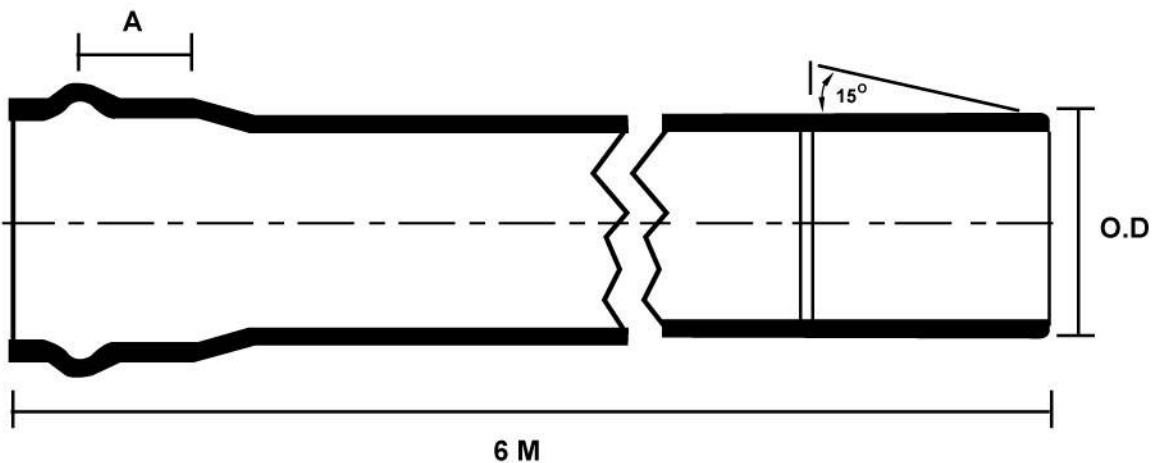

UPVC Pressure Pipe With Rubber - Ring Joint (Bell - Mouth Pipe)

UPVC Pressure Pipe With Solvent Cement Joint



UPVC SOIL, WASTE AND VENTILATING (S.W.V.) PIPES

These pipes are compiled with **MS 1063** which intended to be used for soil and waste discharge pipe work for conveyance of domestic waste water (low and high temperature), ventilating pipe work and rainwater pipe work within building structure. This standard is equivalent to **BS 5255**, **BS 4514**, **BS EN 1401** and **BS EN 1329**.



SPECIFICATIONS OF SOIL, WASTE AND VENTILATING (S.W.V) PIPES

Colour	White
Length	4m or 5.8m
Type of Joint	Solvent Cement Weld Joint

NOMINAL SIZE		MEAN OUTSIDE DIAMETER (mm)		WALL THICKNESS (mm)			
				Application Area			
In.	mm	Min	Max	B		BD	
				Min	Max	Min	Max
1¼	36	36.2	36.5	3.0	3.5	-	-
1½	43	42.8	43.1	3.0	3.5	-	-
2	56	55.8	56.1	3.0	3.5	-	-
3	82	82.4	82.8	3.0	3.5	3.0	3.5
4	110	110.0	110.3	3.2	3.8	3.2	3.8
6	160	160.0	160.4	3.2	3.8	4.0	4.6
8	200	200.0	200.5	3.9	4.5	4.9	5.6
10	250	250.0	250.5	4.9	5.6	6.2	7.1
12	315	315.0	315.6	6.2	7.1	7.7	8.7

Application area code:

Code "B" = Application for components intended for use above ground inside the buildings, or for components outside buildings fixed onto the wall.

Code "BD" = Application for components intended for above ground use for both inside the buildings, or components outside buildings fixed onto the wall and buried in building structures.



UPVC UNDERGROUND DRAINAGE AND SEWERAGE PIPES

These pipes are compiled with **MS 979** and **MS 1063**, which intended to be used for soil and waste discharge systems buried in ground within the building structure. These standards are equivalent to **BS 4660**, **BS 5481** and **BS EN 1329**.



SPECIFICATIONS OF UNDERGROUND DRAINAGE AND SEWERAGE PIPES

Colour	<i>Brown</i>
Length	<i>5.8m</i>
Type of Joint	<i>Solvent Cement Weld Joint</i>

NOMINAL SIZE		MEAN OUTSIDE DIAMETER (mm)		WALL THICKNESS (mm)	
In.	mm	Minimum	Maximum	Minimum	Maximum
4	100	110.0	110.4	3.2	-
6	155	160.0	160.6	4.1	-
8	200	200.0	200.5	4.9	5.6
10	250	250.0	250.5	6.2	7.1
12	315	315.0	315.6	7.7	8.7



UPVC CONDUITS FOR UNDERGROUND TELECOMMUNICATION CABLE

This pipe is complied with MS 1034, which intended to be used for protection to the telephone and electrical cables buried in ground.



SPECIFICATIONS OF CONDUITS FOR UNDERGROUND TELECOMMUNICATION CABLE

Colour	Black
Length	6m
Type of Joint	Solvent Cement Weld Joint

NOMINAL SIZE	OUTSIDE DIAMETER (mm)		WALL THICKNESS (mm)	
	mm	Minimum	Maximum	Minimum
107	107.0	108.0	2.6	3.0



UPVC PRESSURE FITTINGS

45° Elbow

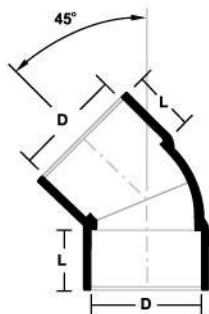

CODE NO	SIZE (mm)	DIMENSION (mm)	
		D	L
FP/E45-040	40	48.2	22.0
FP/E45-050	50	60.3	26.0
FP/E45-065	65	75.1	51.0
FP/E45-080	80	88.8	39.5
FP/E45-100	100	114.5	50.5
FP/E45-155T	155	165.0	82.2
FP/E45-200	200	215.4	99.8
FP/E45-250	250	268.0	133.1
FP/E45-300	300	318.0	151.5

Equal Elbow

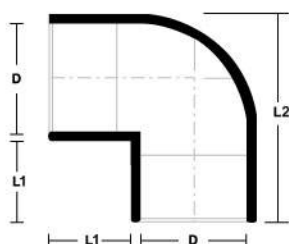

CODE NO	SIZE (mm)	D	DIMENSION (mm)	
			L1	L2
FP/EE-015T	15	21.3	26.8	51.0
FP/EE-020T	20	26.7	29.5	57.0
FP/EE-025T	25	33.5	27.2	67.2
FP/EE-032T	32	42.2	32.1	81.5
FP/EE-040T	40	48.2	38.0	94.4
FP/EE-050T	50	60.3	44.0	117.0
FP/EE-065T	65	75.1	56.6	146.0
FP/EE-080T	80	88.8	79.9	174.5
FP/EE-100T	100	114.2	95.4	228.6
FP/EE-155T	155	165.0	129.1	321.9
FP/EE-200W	200	215.4	105.4	331.0
FP/EE-250W	250	268.0	133.1	412.0
FP/EE-300W	300	318.0	151.5	493.0

Reducing Elbow

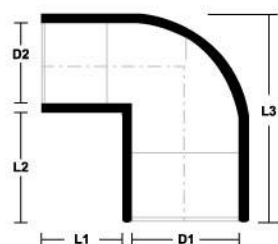

CODE NO	SIZE (mm)	DIMENSION (mm)				
		D1	D2	L1	L2	L3
FP/RE-020*15	20X15	26.7	21.3	22.0	22.0	52.9
FP/RE-025*15	25X15	33.5	21.3	28.0	28.1	60.4
FP/RE-025*20	25X20	33.5	26.7	28.0	28.2	54.6

UPVC PRESSURE FITTINGS

Equal Tee

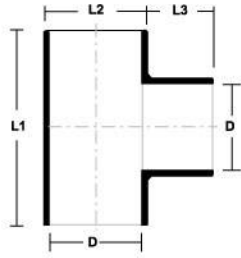

DIMENSION (mm)

CODE NO	SIZE (mm)	D	L1	L2	L3
FP/ET-015T	15	21.3	76.1	26.2	25.1
FP/ET-020T	20	26.7	84.7	33.6	26.3
FP/ET-025T	25	33.5	102.6	40.5	26.8
FP/ET-032T	32	42.2	114.6	50.3	27.1
FP/ET-040T	40	48.2	121.6	56.5	34.1
FP/ET-050T	50	60.3	145.8	67.3	42.4
FP/ET-065T	65	75.1	196.7	85.1	44.4
FP/ET-080T	80	88.8	224.8	97.4	44.7
FP/ET-100T	100	114.2	240.7	122.3	77.4
FP/ET-155W	155	165.0	351.3	176.5	77.6

Reducing Tee

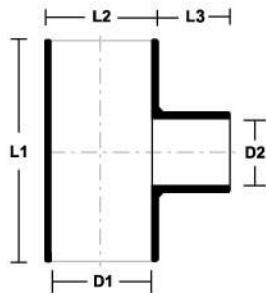

DIMENSION (mm)

CODE NO	SIZE (mm)	D1	D2	L1	L2	L3
FP/RT-020*15	20X15	26.7	21.3	84.8	32.4	28.7
FP/RT-025*15	25X15	33.5	21.3	102.5	40.2	27.2
FP/RT-025*20	25X20	33.5	26.7	102.5	40.2	27.2
FP/RT-032*15	32X15	42.2	21.3	114.4	50.2	28.1
FP/RT-032*20	32X20	42.2	26.7	114.4	50.2	28.1
FP/RT-032*25	32X25	42.2	33.5	114.4	50.2	28.1
FP/RT-040*15	40X15	48.2	21.3	121.5	56.5	34.1
FP/RT-040*20	40X20	48.2	26.7	121.5	56.5	34.1
FP/RT-040*25	40X25	48.2	33.5	121.5	56.5	34.1
FP/RT-040*32	40X32	48.2	42.2	121.5	56.5	34.1
FP/RT-050*15	50X15	60.3	21.3	145.4	69.4	42.3
FP/RT-050*20	50X20	60.3	26.7	145.4	69.4	42.3
FP/RT-050*25	50X25	60.3	33.5	145.4	69.4	42.3
FP/RT-050*32	50X32	60.3	42.2	145.4	69.4	42.3
FP/RT-050*40	50X40	60.3	48.2	145.4	69.4	42.3
FP/RT-065*40	65X40	75.1	48.2	196.5	84.5	59.2
FP/RT-065*50	65X50	75.1	60.3	196.5	84.5	60.8
FP/RT-080*25T	80X25	88.8	33.5	224.4	101.5	66.0
FP/RT-080*32T	80X32	88.8	42.2	224.4	101.5	66.0
FP/RT-080*50T	80X50	88.8	60.3	224.4	101.5	66.0
FP/RT-100*50T	100X50	114.2	60.3	248.6	129.3	71.9
FP/RT-100*80T	100X80	114.2	88.8	248.6	129.3	71.9
FP/RT-155*110W	155X100	165.0	114.2	225.9	101.8	66.1

UPVC PRESSURE FITTINGS

Faucet (P/T) Socket

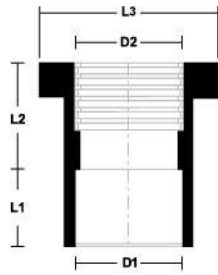

CODE NO	SIZE (mm)	DIMENSION (mm)				
		D1	D2	L1	L2	L3
FP/PTS-015	15	21.3	22.0	24.2	24.2	30.2
FP/PTS-020	20	26.7	26.8	24.4	32.0	34.2
FP/PTS-025	25	33.5	33.5	28.1	37.2	43.5
FP/PTS-032	32	42.2	42.8	41.9	26.5	52.7
FP/PTS-040	40	48.2	48.4	45.1	33.8	59.6
FP/PTS-050	50	60.3	60.2	60.0	37.7	71.8
FP/PTS-065	65	75.1	74.9	69.0	38.0	86.6
FP/PTS-080	80	88.8	84.3	73.8	44.3	105.8
FP/PTS-100	100	114.2	110.0	89.9	57.9	114.1

Faucet (P/T) Elbow

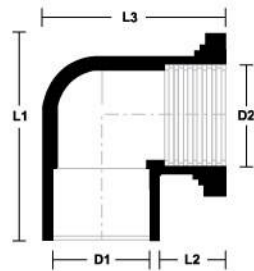

CODE NO	SIZE (mm)	DIMENSION (mm)				
		D1	D2	L1	L2	L3
FP/PTE-015	15	21.3	22.0	57.9	16.9	48.2
FP/PTE-020	20	26.7	26.8	59.5	24.5	56.6
FP/PTE-025	25	33.5	33.5	68.7	26.5	69.4
FP/PTE-032	32	42.2	42.8	75.0	24.3	76.8
FP/PTE-040	40	48.2	48.4	95.1	27.2	86.1
FP/PTE-050	50	60.3	60.2	106.4	33.0	102.3

Faucet (P/T) Tee

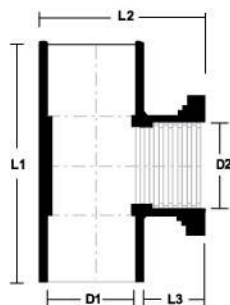

CODE NO	SIZE (mm)	DIMENSION (mm)				
		D1	D2	L1	L2	L3
FP/PTT-015	15	21.3	22.0	66.0	40.1	16.9

UPVC PRESSURE FITTINGS

Valve Socket

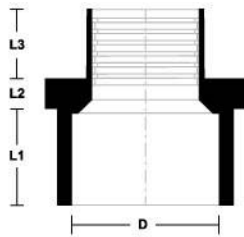
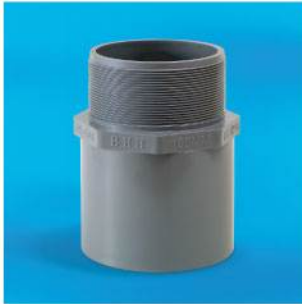

DIMENSION (mm)

CODE NO	SIZE (mm)	D	L1	L2	L3
FP/VS-015	15	21.3	26.3	7.8	17.5
FP/VS-020	20	26.7	29.9	7.6	20.1
FP/VS-025	25	33.5	31.1	8.2	23.8
FP/VS-032	32	42.2	36.3	8.9	24.3
FP/VS-040	40	48.2	42.6	10.2	26.3
FP/VS-050	50	60.3	67.8	11.5	30.6
FP/VS-065	65	75.1	64.5	14.7	34.6
FP/VS-080	80	88.8	66.8	16.2	40.2
FP/VS-100	100	114.2	102.1	24.8	54.6

V-Tank Connector

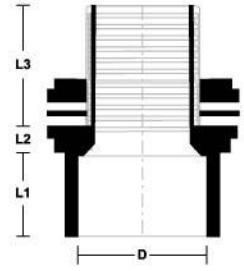

DIMENSION (mm)

CODE NO	SIZE (mm)	D	L1	L2	L3
FP/TC-015V	15	21.3	32.6	11.0	32.7
FP/TC-020V	20	26.7	33.6	11.0	37.8
FP/TC-025V	25	33.5	42.4	10.6	40.1
FP/TC-032V	32	42.2	51.5	11.6	57.9
FP/TC-040V	40	48.2	62.8	13.3	56.9
FP/TC-050V	50	60.3	64.5	14.7	34.6

Double End (DE) Socket

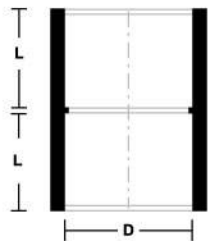

DIMENSION (mm)

CODE NO	SIZE (mm)	D	L
FP/DES-015T	15	21.3	21.1
FP/DES-020T	20	26.7	22.3
FP/DES-025T	25	33.5	22.7
FP/DES-032T	32	42.2	43.0
FP/DES-040T	40	48.2	42.8
FP/DES-050T	50	60.3	53.4
FP/DES-065T	65	75.1	67.8
FP/DES-080T	80	88.8	78.5
FP/DES-100T	100	114.2	99.4
FP/DES-155T	155	165.0	149.7
FP/DES-200W	200	215.4	146.5

UPVC PRESSURE FITTINGS

Reducing Bush

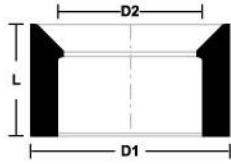

CODE NO	SIZE (mm)	DIMENSION (mm)		
		D1	D2	L
FP/RB-020*15	20X15	26.7	21.3	21.2
FP/RB-025*15	25X15	33.5	21.3	26.4
FP/RB-025*20	25X20	33.5	26.7	26.8
FP/RB-032*15	32X15	42.2	21.3	31.7
FP/RB-032*20	32X20	42.2	26.7	31.7
FP/RB-032*25	32X25	42.2	33.5	31.7
FP/RB-040*15	40X15	48.2	21.3	34.1
FP/RB-040*20	40X20	48.2	26.7	34.1
FP/RB-040*25	40X25	48.2	33.5	34.1
FP/RB-040*32	40X32	48.2	42.2	34.1
FP/RB-050*15	50X15	60.3	21.3	37.4
FP/RB-050*20	50X20	60.3	26.7	37.4
FP/RB-050*25	50X25	60.3	33.5	37.4
FP/RB-050*32	50X32	60.3	42.2	37.4
FP/RB-050*40	50X40	60.3	48.2	37.6
FP/RB-100*80	100X80	114.2	88.8	42.7

Reducing Socket

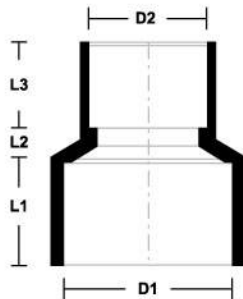

CODE NO	SIZE (mm)	DIMENSION (mm)				
		D1	D2	L1	L2	L3
FP/RS-020*15	20X15	26.7	21.3	21.2	11.9	17.3
FP/RS-025*15	25X15	33.5	21.3	24.3	10.5	19.9
FP/RS-025*20	25X20	33.5	26.7	24.5	11.9	21.9
FP/RS-032*15	32X15	42.2	21.3	27.2	17.2	25.7
FP/RS-032*20	32X20	42.2	26.7	27.2	17.2	25.9
FP/RS-032*25	32X25	42.2	33.5	28.0	16.3	25.9
FP/RS-040*15	40X15	48.2	21.3	28.7	16.5	28.0
FP/RS-040*20	40X20	48.2	26.7	28.7	16.3	28.0
FP/RS-040*25	40X25	48.2	33.5	28.6	16.6	28.0
FP/RS-040*32	40X32	48.2	42.2	28.6	16.7	28.1
FP/RS-050*15	50X15	60.3	21.3	35.5	16.7	33.4
FP/RS-050*20	50X20	60.3	26.7	35.6	16.6	33.3
FP/RS-050*25	50X25	60.3	33.5	34.4	15.1	36.1
FP/RS-050*32	50X32	60.3	42.2	38.1	15.2	33.3
FP/RS-050*40	50X40	60.3	48.2	35.5	16.2	33.1
FP/RS-065*50	65X50	75.1	60.3	64.4	14.7	59.6
FP/RS-080*40	80X40	88.8	48.2	40.4	25.3	29.8
FP/RS-080*50T	80X50	88.8	60.3	66.5	33.6	63.6
FP/RS-100*50T	100X50	114.2	60.3	99.4	19.1	70.4
FP/RS-100*80T	100X80	114.2	88.8	98.9	20.9	68.9
FP/RS-155*100T	155X100	165.5	114.2	119.3	38.8	96.9

UPVC PRESSURE FITTINGS

End Cap

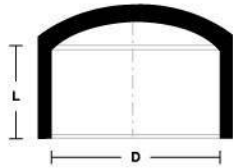

DIMENSION (mm)

CODE NO	SIZE (mm)	D	L
FP/EC-015	15	21.3	18.8
FP/EC-020	20	26.7	21.8
FP/EC-025	25	33.5	24.2
FP/EC-032	32	42.2	31.6
FP/EC-040	40	48.2	31.7
FP/EC-050	50	60.3	32.0
FP/EC-065	65	75.1	64.6
FP/EC-080	80	88.8	67.4
FP/EC-100	100	114.2	96.0
FP/EC-155	155	165.0	145.2

Flange

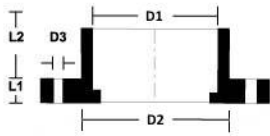

DIMENSION (mm)

CODE NO	SIZE (mm)	D1	D2	D3	L1	L2
FP/FLG-025	25	33.5	36.6	17.8	13.9	39.7
FP/FLG-040	40	48.2	47.7	18.0	15.6	52.8
FP/FLG-050	50	60.3	60.7	19.7	18.7	64.0
FP/FLG-065	65	75.1	75.6	22.1	16.9	69.4
FP/FLG-080	80	88.8	93.5	19.8	21.0	72.1
FP/FLG-100	100	114.2	114.6	19.8	23.8	82.8
FP/FLG-155	155	165.0	170.0	24.2	24.8	127.8

Plug

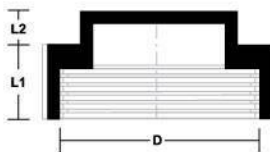
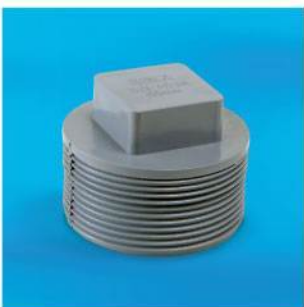

DIMENSION (mm)

CODE NO	SIZE (mm)	D	L1	L2
FP/PL-015	15	21.3	12.4	11.5
FP/PL-020	20	26.7	16.1	10.0
FP/PL-025	25	33.5	17.7	14.6
FP/PL-032	32	42.2	26.7	17.6
FP/PL-040	40	48.2	26.8	17.0
FP/PL-050	50	60.3	27.2	17.0

UPVC SOIL, WASTE AND VENTILATING (S.W.V.) FITTINGS

135° Plain Bend

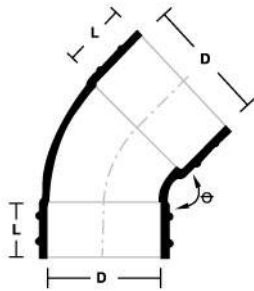

CODE NO	SIZE (mm)	ANGLE (°)	DIMENSION (mm)	
			D	L
FU/135BP-032S	32	135	36.3	24
FU/135BP-040S	40	135	42.9	25
FU/135BP-050S	50	135	55.9	28
FU/135BP-082S	82	135	82.6	45
FU/135BP-110S	110	135	110.2	50
FU/135BP-160S	160	135	160.4	78
FU/135BP-200S	200	135	200.2	100
FU/135BP-250S	250	135	250.4	83.2
FU/135BP-315S	315	135	315.5	102.2

Sweep Bend

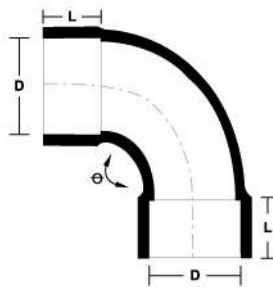

CODE NO	SIZE (mm)	ANGLE (°)	DIMENSION (mm)	
			D	L
FU/SB-032S	32	91.25	36.3	24
FU/SB-040S	40	91.25	42.9	25
FU/SB-050S	50	91.25	55.9	28
FU/SB-082S	82	92.5	82.6	45
FU/SB-110S	110	92.5	110.2	50
FU/SB-160S	160	92.5	160.4	78
FU/SB-200S	200	92.5	200.2	99.3
FU/SB-250S	250	92.5	250.4	83.2
FU/SB-315S	315	92.5	315.5	102.2

Sweep Bend With I / O

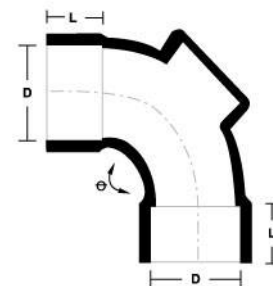

CODE NO	SIZE (mm)	ANGLE (°)	DIMENSION (mm)	
			D	L
FU/SB-050S*I	50	91.25	55.9	28
FU/SB-082S*I	82	91.25	82.6	45
FU/SB-110S*I	110	91.25	110.2	50
FU/SB-160S*I	160	92.5	160.4	78
FU/SB-200S*I	200	92.5	200.4	99.3

UPVC SOIL, WASTE AND VENTILATING (S.W.V.) FITTINGS

Equal Single Branch

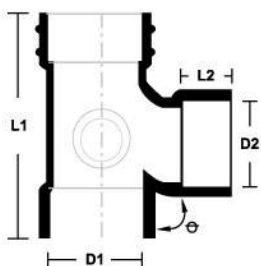

CODE NO	SIZE (mm)	ANGLE (°)	DIMENSION (mm)			
			D1	D2	L1	L2
FU/ESB-032S	32	91.25	36.3	36.3	89	24
FU/ESB-040S	40	91.25	42.9	42.9	109	25
FU/ESB-050S	50	91.25	55.9	55.9	135	28
FU/ESB-082S	82	92.5	82.6	82.6	205	45
FU/ESB-110S	110	92.5	110.2	110.2	270	50
FU/ESB-110*50S	110X50	92.5	110.2	55.9	270	29.9
FU/ESB-110*82S	110X82	92.5	110.2	82.6	270	47.8
FU/ESB-160*110S	160X110	92.5	160.4	110.2	315	52
FU/ESB-160S	160	92.5	160.4	160.4	376	75.3
FU/ESB-200S	200	92.5	200.2	200.2	395.2	83.6

Equal Single Branch With I / O

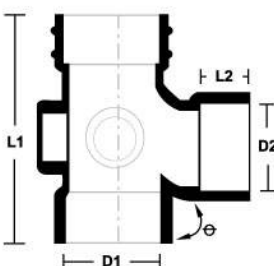

CODE NO	SIZE (mm)	ANGLE (°)	DIMENSION (mm)			
			D1	D2	L1	L2
FU/ESB-050S*I	50	91.25	55.9	55.9	135	28
FU/ESB-082S*I	82	92.5	82.6	82.6	205	45
FU/ESB-110S*I	110	92.5	110.2	110.2	270	50
FU/ESB-110*50S*I	110X50	92.5	110.2	55.9	270	29.9
FU/ESB-110*82S*I	110X82	92.5	110.2	82.6	270	47.8
FU/ESB-160*110I	160X110	92.5	160.4	110.2	315	52
FU/ESB-160S*I	160	92.5	160.4	160.4	376	75.3

135° Y-Branch (Y-Tee)

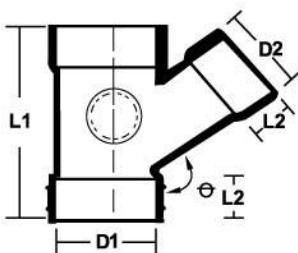

CODE NO	SIZE (mm)	ANGLE (°)	DIMENSION (mm)			
			D1	D2	L1	L2
FU/YT-040S	40	135	42.9	42.9	110	25
FU/YT-050S	50	135	55.9	55.9	135	28
FU/YT-082S	82	135	82.6	82.6	205	46.5
FU/YT-110S	110	135	110.2	110.2	255	50
FU/YT-100S*I	110	135	110.2	110.2	255	50
FU/YT-160S	160	135	160.4	160.4	315	73.5
FU/YT-160*110S	160X110	135	160.4	110.2	376	52.1
FU/YT-200S	200	135	200.4	200.4	428	62

UPVC SOIL, WASTE AND VENTILATING (S.W.V.) FITTINGS

2-Way Junction (Cross Tee)

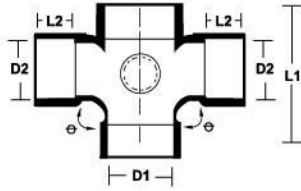

CODE NO	SIZE (mm)	ANGLE (°)	DIMENSION (mm)			
			D1	D2	L1	L2
FU/CT-110*110S	110X110	92.5	110.2	110.2	270	50
FU/CT-160*110S	160X110	92.5	160.4	110.2	315.3	50

Faucet (P / T) Socket

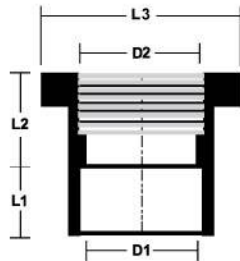

CODE NO	SIZE (mm)	DIMENSION (mm)				
		D1	D2	L1	L2	L3
FU/PTS-032S	32	36.3	42.2	27.5	34.8	52.8
FU/PTS-040S	40	42.9	48.2	31.7	39.2	59.5

Faucet (P / T) Elbow

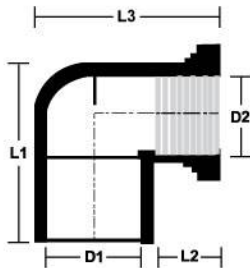

CODE NO	SIZE (mm)	DIMENSION (mm)				
		D1	D2	L1	L2	L3
FU/PTE-032S	32	36.3	42.2	72.8	24.4	69.4
FU/PTE-040S	40	42.9	48.2	79.5	27.6	85.0

UPVC SOIL, WASTE AND VENTILATING (S.W.V.) FITTINGS

Boss Connector

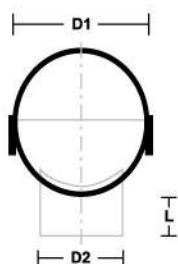

CODE NO	SIZE (mm)	DIMENSION (mm)		
		D1	D2	L
FU/BC-082*50S	82X50	82.6	55.9	28
FU/BC-110*50S	110X50	110.2	55.9	28
FU/BC-110*82S	110X82	110.2	82.6	45
FU/BC-160*82S	160X82	160.4	82.6	45
FU/BC-160*110S	160X110	160.4	110.2	50

Straight Coupling

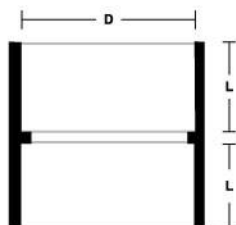

CODE NO	SIZE (mm)	DIMENSION (mm)	
		D	L
FU/SC-032S	32	36.3	24
FU/SC-040S	40	42.9	25
FU/SC-050S	50	55.9	28
FU/SC-082S	82	82.6	45
FU/SC-110S	110	110.2	50
FU/SC-160S	160	160.4	78
FU/SC-200S	200	200.4	122.5
FU/SC-250S	250	250.4	83.2
FU/SC-315S	315	315.5	102.2

Pipe Sleeve

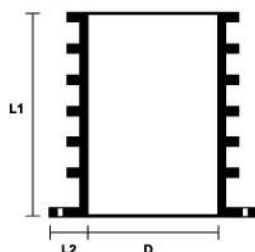

CODE NO	SIZE (mm)	DIMENSION (mm)		
		D1	L1	L2
FU/PS-050S	50	56.3	110.2	14.4
FU/PS-082S	82	82.8	110.8	16.8
FU/PS-110S	110	110.2	111.5	22.6
FU/PS-160S	160	160.4	148.5	23.3
FU/PS-200S	200	200.4	122.5	179

UPVC SOIL, WASTE AND VENTILATING (S.W.V.) FITTINGS

Bush Reducer



CODE NO	SIZE (mm)	DIMENSION (mm)			
		D1	D2	L1	L2
FU/SR-040*32S	40X32	42.9	36.3	22	19
FU/SR-050*32S	50X32	55.9	36.3	28	19
FU/SR-050*40S	50X40	55.9	42.9	28	22
FU/SR-082*50S	82X50	82.6	55.9	45	28
FU/SR-110*50S	110X50	110.2	55.9	50	28
FU/SR-110*82S	110X82	110.2	82.6	50	45
FU/SR-160*82S	160X82	160.4	82.6	78	45
FU/SR-160*110S	160X110	160.4	110.2	78	50
FU/SR-200*110S	200X110	200.2	110.2	80	48
FU/SR-200*160S	200X160	200.2	160.2	80	58

Level Invert Reducer

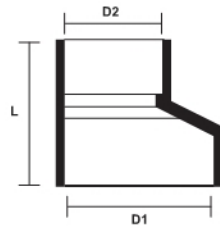

CODE NO	SIZE (mm)	DIMENSION (mm)		
		D1	D2	L
FU/RS-110*50S	110X50	110.2	55.9	124.6
FU/RS-110*82S	110X82	110.2	82.6	124.5
FU/RS-200*110S	200X110	200.2	110.2	160.0
FU/RS-200*160S	200X160	200.2	160.2	160.0

Concentric Reducer

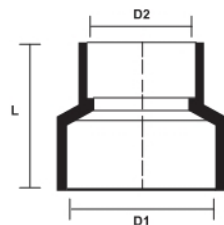

CODE NO	SIZE (mm)	DIMENSION (mm)		
		D1	D2	L
FU/RS-160*110S	160X110	160.4	110.2	141.3

UPVC SOIL, WASTE AND VENTILATING (S.W.V.) FITTINGS

P - Trap

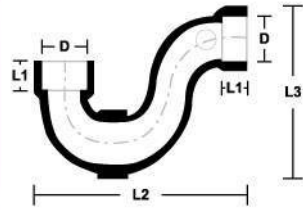

CODE NO	SIZE (mm)	DIMENSION (mm)			
		D	L1	L2	L3
FU/PT-110S	110	110.2	50	380	270

P - Trap With I / O

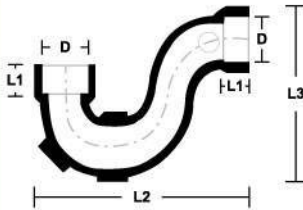

CODE NO	SIZE (mm)	DIMENSION (mm)			
		D	L1	L2	L3
FU/PT-050S*I	50	55.9	28	240	180
FU/PT-110S*I	110	110.2	50	380	270

S - Trap With I / O

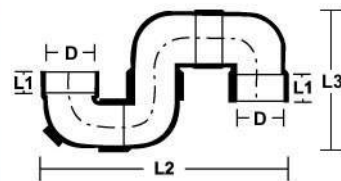

CODE NO	SIZE (mm)	DIMENSION (mm)			
		D	L1	L2	L3
FU/ST-110S*I	110	110.2	50	470	285

Floor Gully

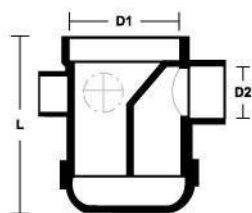

CODE NO	SIZE (mm)	DIMENSION (mm)		
		D1	D2	L
FU/FG-110*50S	110X50	110.2	55.9	190.5
FU/FG-110*82S	110X82	110.2	82.6	190.5
FU/FG-110*5*5S	110X50X50	110.2	55.9	190.5

UPVC SOIL, WASTE AND VENTILATING (S.W.V.) FITTINGS

End Cap

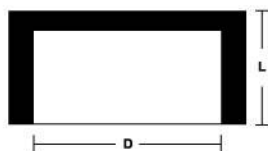

CODE NO	SIZE (mm)	DIMENSION (mm)	
		D	L
FU/EC-050S	50	55.9	35
FU/EC-110S	110	110.2	25

Vent Cowl

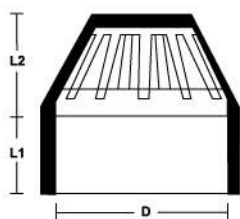

CODE NO	SIZE (mm)	DIMENSION (mm)		
		D	L1	L2
FU/VC-050S	50	55.9	29.8	43.2
FU/VC-082S	82	82.6	25	48
FU/VC-110S	110	110.2	26	64
FU/VC-160S	160	160.4	51.9	90.1

Access Plug

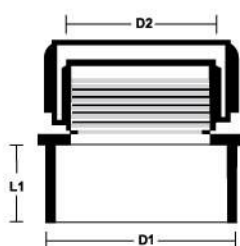

CODE NO	SIZE (mm)	DIMENSION (mm)		
		D1	D2	L1
FU/AP-040S	40	42.9	44.3	42.7
FU/AP-050S	50	55.9	45.4	44.3
FU/AP-082S	82	82.6	87.0	51.5
FU/AP-110S	110	110.2	76.5	84.3
FU/AP-160S	160	160.4	159	95

UPVC UNDERGROUND DRAINAGE AND SEWERAGE FITTINGS

135° Plain Bend

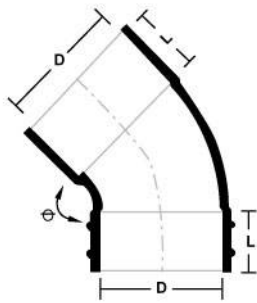

		DIMENSION (mm)		
CODE NO	SIZE (mm)	ANGLE (°)	D	L
FUG/135BP-110S	110	135	110.2	50
FUG/135BP-160S	160	135	160.4	78

Sweep Bend

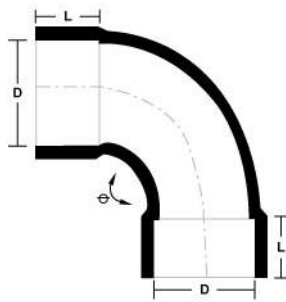

		DIMENSION (mm)		
CODE NO	SIZE (mm)	ANGLE (°)	D	L
FUG/SB-110S	110	92.5	110.4	52
FUG/SB-160S	160	92.5	160.4	79.8

Straight Coupling

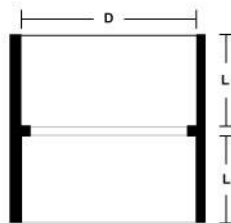

		DIMENSION (mm)	
CODE NO	SIZE (mm)	D	L
FUG/SC-110S	110	110.2	50
FUG/SC-160S	160	160.4	78

UPVC UNDERGROUND DRAINAGE AND SEWERAGE FITTINGS

Equal Single Branch

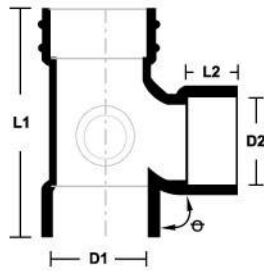

CODE NO	SIZE (mm)	ANGLE (°)	DIMENSION (mm)			
			D1	D2	L1	L2
FUG/ESB-110S	110	92.5	110.2	110.2	250	50
FUG/ESB-160S	160	92.5	160.4	160.4	370	77

P - Trap

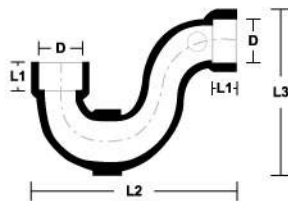

CODE NO	SIZE (mm)	D	DIMENSION (mm)		
			L1	L2	L3
FUG/PT-110S	110	110.2	50	380	270

QUALITY ASSURANCE

We committed to supply the best quality products to our customers. Every production processes from the start to end are strictly monitored and recorded. Well-trained staffs are exercising inspection and quality control using calibrated equipments. Our factory had been equipped with all necessary testing equipments.



Appearance, dimensions and ovality inspection



Hydrostatic Pressure Test



Impact Test



Heat Reversion Test



Acetone Test



Tensile Test

All tests are carried out in our laboratory and the results have been properly recorded. We assure that only products which pass our stringent testing in compliance with the relevant standard's requirements will only be sold to the market.

Pipe installation with Solvent Cement Joints



1. Joint Preparation - Cut pipe square with the axis, using a fine-tooth saw with a miter box or guide. Remove all burrs and break the sharp lead edges.



2. Cleaning - Surfaces to be joined must be cleaned and free of dirt, moisture, oil, and other foreign material.



3. Application of Solvent Cement - PVC solvent cement is fast drying and should be applied as quickly as possible, consistent with good workmanship. Follow the manufacturer's recommendations for application of solvent cement.



4. Joint Assembly - While both the inside socket surface and the outside surface of the spigot of the pipe are WET with solvent cement, forcefully bottom the spigot in the socket. Turn the pipe or fitting 1/4 turn during assembly (but not after the pipe is bottomed) to distribute the cement evenly. Assembly should be completed within 30 seconds after the last application of solvent cement.



5. After assembly - Wipe excess cement from the pipe at the end of the socket. Any gaps in the cement bead around the pipe perimeter may indicate a defective assembly. Handle the newly assembled joints carefully after 1 hour.

Important Points of Pipe Installation with Solvent Cement Joints

1. The joining surfaces must be clean and dry.
2. Sufficient cement must be applied to fill the gap between male and female ends.
3. The assembly must be made while the surfaces are still wet and fluid.
4. Completed joints should not be disturbed until they have cured sufficiently to withstand handling.
5. Keep the solvent cement closed and shaded when not actually in use. Discard the solvent cement when a noticeable change in viscosity occurs, when the cement does not flow freely from the brush, or when the cement appears lumpy and stringy.

Pipe installation with Rubber - Ring Joints



1. Clean the socket area. Remove sand, dirt, grease and debris.



2. Insert the rubber ring into the ring groove.



3. a) Clean the spigot end of the pipe as far back as the reference line.

b) Apply lubricant to the spigot end and approximately mid-way back to the reference line.



4. Insert the spigot end into the socket until it contacts the rubber ring uniformly. Apply steady pressure by hand or by mechanical means until the spigot slips through the rubber ring. Insert pipe until the reference line is just visible at the face of each socket.

Important Points of Pipe Installation with Rubber - Ring Joints

1. The rubber ring is correctly fitted when the thickness cross section of the ring is positioned towards the outside of the socket and groove in the rubber ring is positioned inside the socket.
2. Check the rubber ring to make sure it is sealed uniformly in the ring groove by running your finger around the inner edge of the rubber ring.
3. Keep lubricant areas clean. If dirt or sand adheres to lubricated areas, clean and re-lubricate.
4. Bar and block assembly is recommended because a worker is able feel the amount of force being used and whether the joint goes together smoothly.

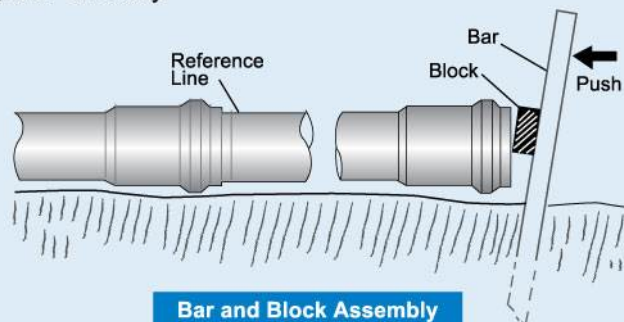

5. If undue resistance to pipe insertion is encountered, disassemble the joint and check the position of the rubber ring
 - If the rubber ring has been dislocated from the ring groove, inspect the pipe and rubber ring for damage, replace damaged items, clean components and repeat the installation steps.
 - If the rubber ring is still properly positioned, verify proper positioning of the reference line. Relocate the line if it is not correctly positioned.
 - If the pipe still cannot be inserted properly, please do contact us for assistance.

BINA PLASTIC UPVC PIPES AND FITTINGS

Our products have been tested and certified to conform to the relevant standard specifications and are licensed by SIRIM to be used as the top mark for quality. The granting of the top mark confirms that the company's manufacturing, testing and quality control systems complies with the stringent licensing requirements and thus ensures that products quality is consistently maintained.

Certified to brand BBB™



MS628 : Pt 1: 1999

UPVC pipes for cold water services

MS 628 : Pt 2 : 1999

UPVC joints and fittings for UPVC pressure pipes

MS 762 : 1982

UPVC pipes for industrial use

BS 4346 : Pt 1 : 1969 (1998)

UPVC joints and fittings for UPVC pressure pipes

MS 1063 : 2002 (BS EN 1329 : 2000)

UPVC pipes and fittings for soil and waste discharge

BS 4576 : 1989

UPVC rainwater pipes

MS 979 : Pt 1 : 1985 (BS 4660 : 1989)

UPVC pipes and fittings for underground drainage

MS 1034 : 1986

UPVC conduits for underground telecommunication cable



BINA PLASTIC

INDUSTRIES SDN BHD

(C.O. No. 54840-T)

Lot 4844, Balakong New Village Industrial Estate,
43300 Seri Kembangan, Selangor Darul Ehsan, Malaysia

Factory 1:

Tel 603 8961 2211 /
8961 2212 /
8961 1031 /
8962 2213

Factory 2:

Tel 603 8961 2107 /
8961 2084 /
8961 1319 /
8961 5792

Fax 603 8961 2313 /
8961 1348

Fax 603 8961 2544

Website : www.binaplast.com

Email : info@binaplast.com